

Article number: 439500100

Description: Rota-fix shaft-hub connection F100x145
Steel

Note: Self centering. Very high torque

Measures

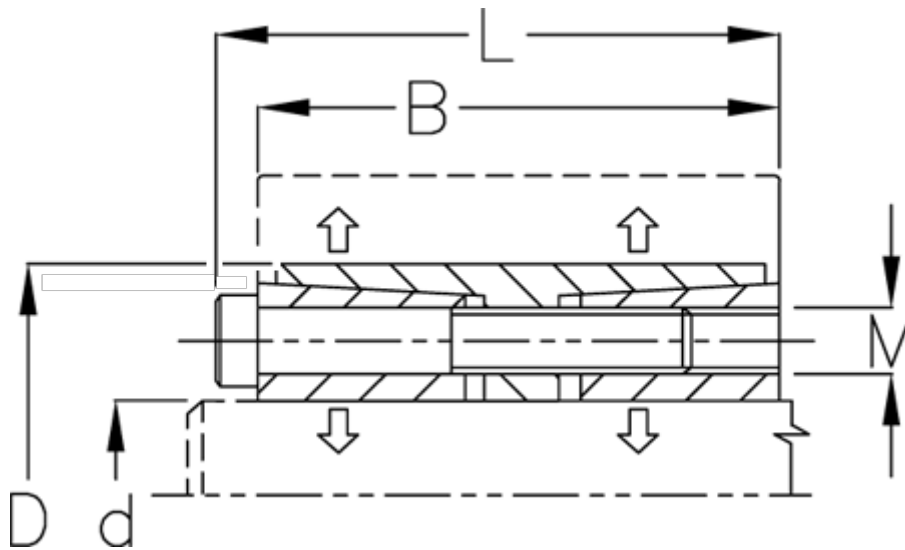

B mm	= 98
d H8 mm	= 100
D mm	= 145
Fit tolerance	= Aksel h8, Nav H8
F kN torque	= 500.0
L mm	= 110
M mm	= M12
P N/mm ² surface pressure on shaft/hub	= 100

Surface roughness	= R? ? 3.2 µm
T N m torque	= 26000
Ts N m bolt tightening torque	= 145.0